

M12 1239 ... T0CB

Panel Mount Connectors M12



M12 insert connector, male, A-coded, IP67, with solder cups

M12 1239 ... T0CB

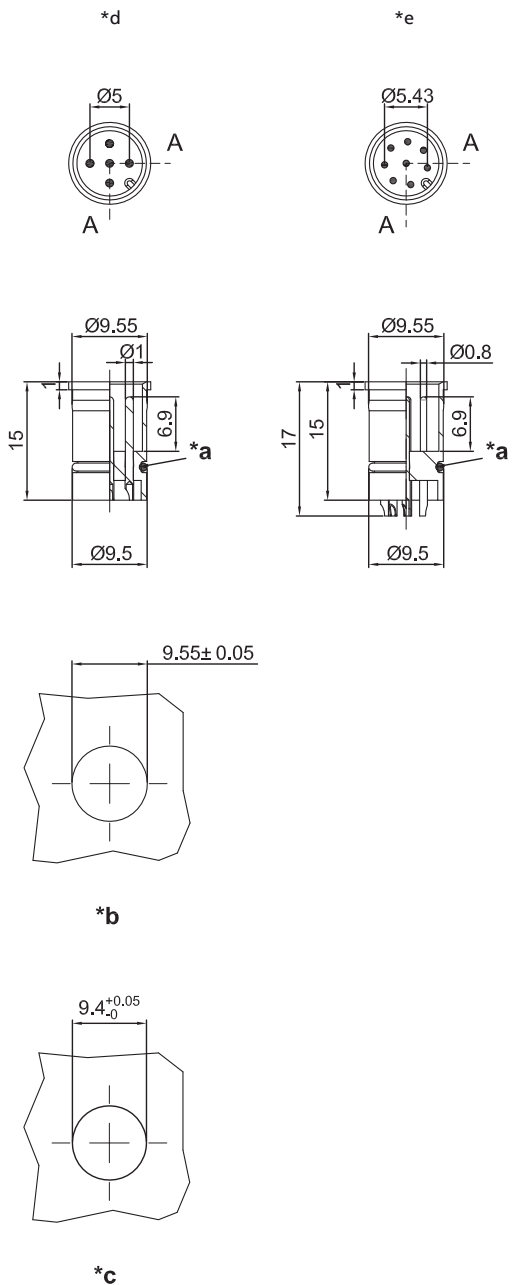

Environmental conditions

Temperature range -25 °C/+80 °C

Materials

Insulating body PA
Contact pin CuZn, pre-nickel and gold-plated
Seal FKM

Mechanical data

Mating cycles ≥ 100
Insertion force $\leq 10 \text{ N}^1$
Withdrawal force $\leq 15 \text{ N}^1$
Protection class IP67²

¹ measured with a proper counterpart

² according to IEC DIN EN 60529, only in locked condition with an appropriate counterpart















Electrical data (at $T_{\text{amb}} 20 \text{ °C}$)

Contact resistance $\leq 5 \text{ m}\Omega$
Rated current 4 A (3–5 poles)
2 A (8 poles)
($T_{\text{amb}} 40 \text{ °C}$)
Rated voltage 250 V AC/DC (3–4 poles)
60 V AC/DC (5 poles)
30 V AC/DC (8 poles)
(with pollution degree 3)¹
Rated impulse voltage 2000 V (3–4 poles)
1500 V (5–8 poles)¹
Material group I (IEC)/0 (UL) (CTI ≥ 600)²
Overvoltage category II²
Insulation resistance $> 1 \text{ G}\Omega$

¹ acc. to IEC 60664/DIN EN 60664/CTI UL classification acc. to ANSI/UL 746A

² acc. to IEC 60664/DIN EN 60664/CTI UL classification acc. to ANSI/UL 746A

Associated products

Counterparts
 1200 ... 0...  1200 ... 3...  1205 ... 0...
 1205 ... 3...  1206 ... L1 0...  1206 ... L1 3...
 1206 ... L2 0...  1206 ... L2 3...  1210 1200 ... 0...
 1210 1200 ... 3...  1210 1205 ... 3...  1210 1206 ... L1 0...
 1210 1206 ... L1 3...  1210 1206 ... L2 0...  1210 1206 ... L2 3...

M12

1239 ... T0CB

Pin assignment for male M12 connectors, A-coded, front view

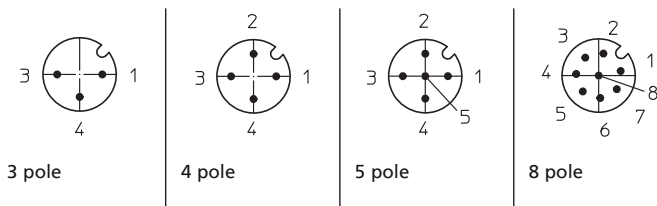

- *a O-ring is packed separately
- *b port, with O-ring
- *c port, without O-ring
- *d 3-5 poles
- *e 8 poles

M12

1239 ... TOCB

Designation	Pole Number	PU (Pieces)	MDQ (Pieces)
1239 03 TOCB	3	50	50
1239 04 TOCB	4	50	50
1239 05 TOCB	5	50	50
1239 08 TOCB	8	50	50

Packaging:
in a plastic bag